

NIKONOS-II

(Work No. 9F2B)

REPAIR MANUAL

NIPPON KOGAKU K.K.

Tokyo, Japan

C O N T E N T S

	Page
Illustrations	1 - 9
List of O-ring	10
Parts list	11 - 36
Subassembly list	37 - 38

NOTE:

1. In the Illustrations the types of lubricant and adhesive to be used for the parts are indicated by the markings as below;

Lubricant:	▽	Grease (for low temp.)
	▼	O-ring grease
	◇	Oil (for low temp.)
	◆	Molybdenum disulphide grease
	◊	Gyro-oil
Adhesive:	⊗	Clear laquer
	⊗	Epoxy resin adhesive
	⊞	Synthetic rubber adhesive

2. Marks in the "Term of Sale" column of the parts list are;

○	Can be supplied individually
△	Not supplied individually but only as subassembly
○△	Supplied either as part or subassembly
×	Not considered as repair part
⊞	Delivered as a product from the Sales Department (i.e., not supplied as repair part)

3. The parts marked * in the column "Remarks" in the Parts List are those which can commonly be used for 9FB (NIKONOS MODEL 1).

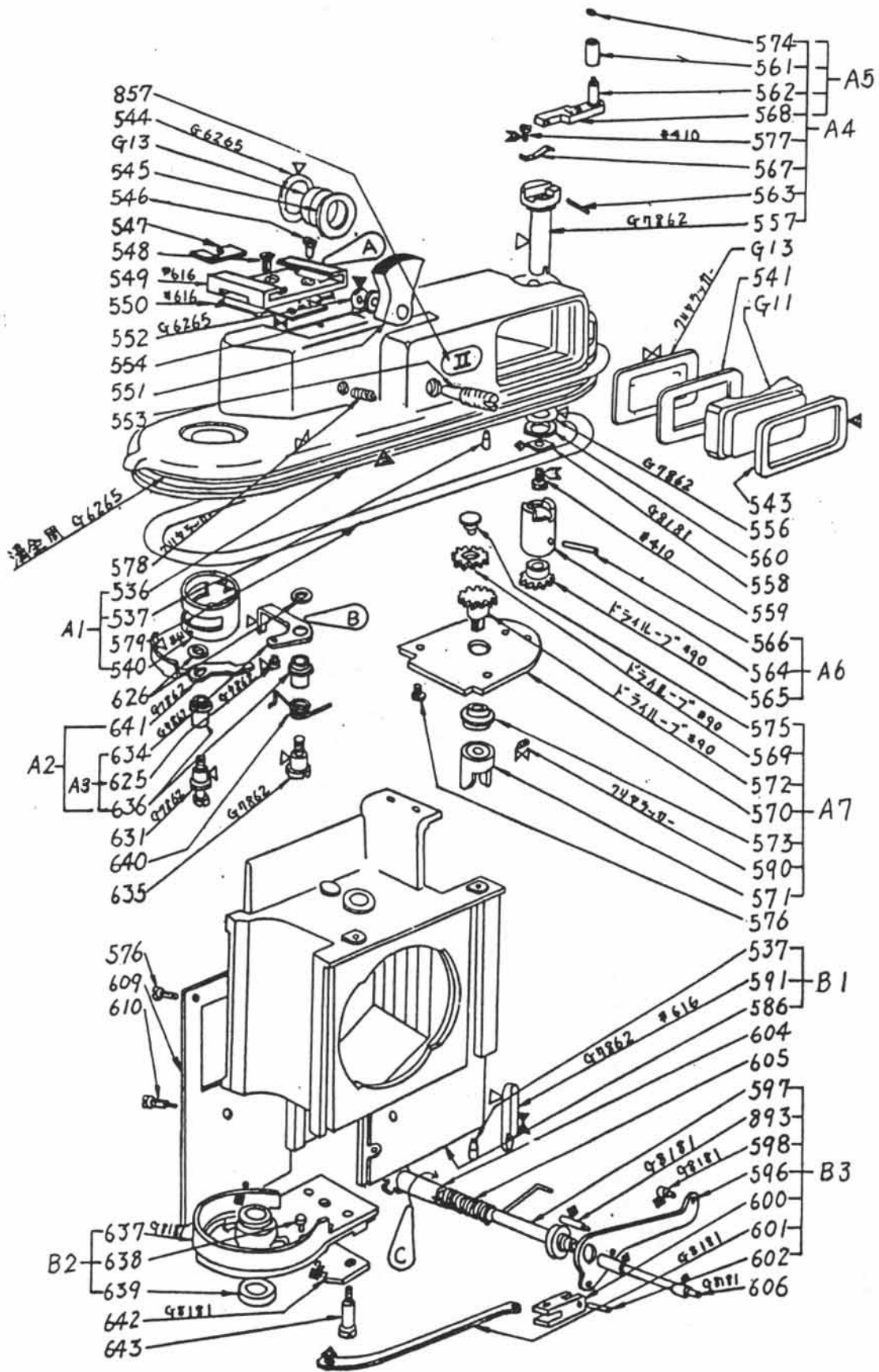

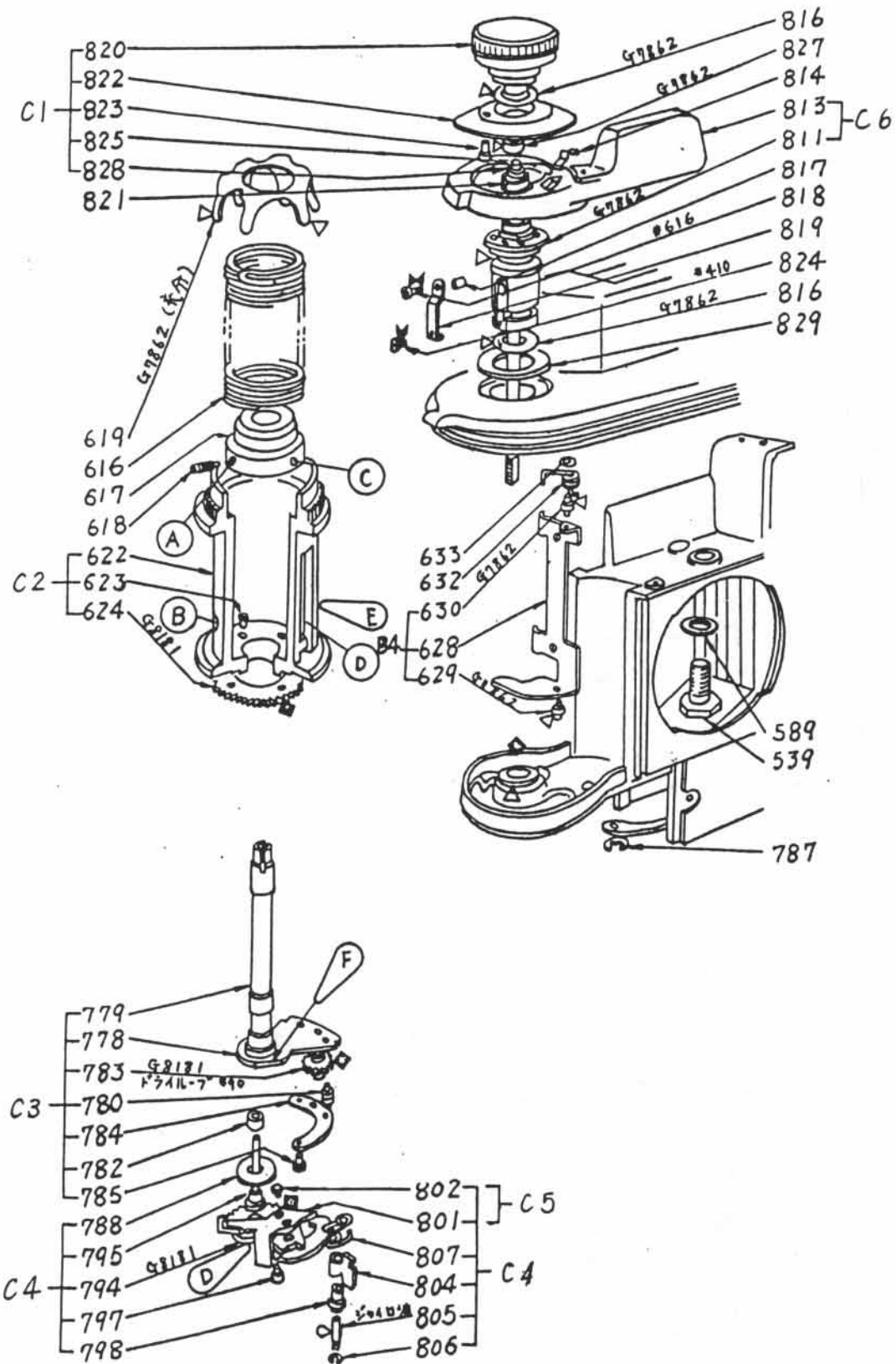

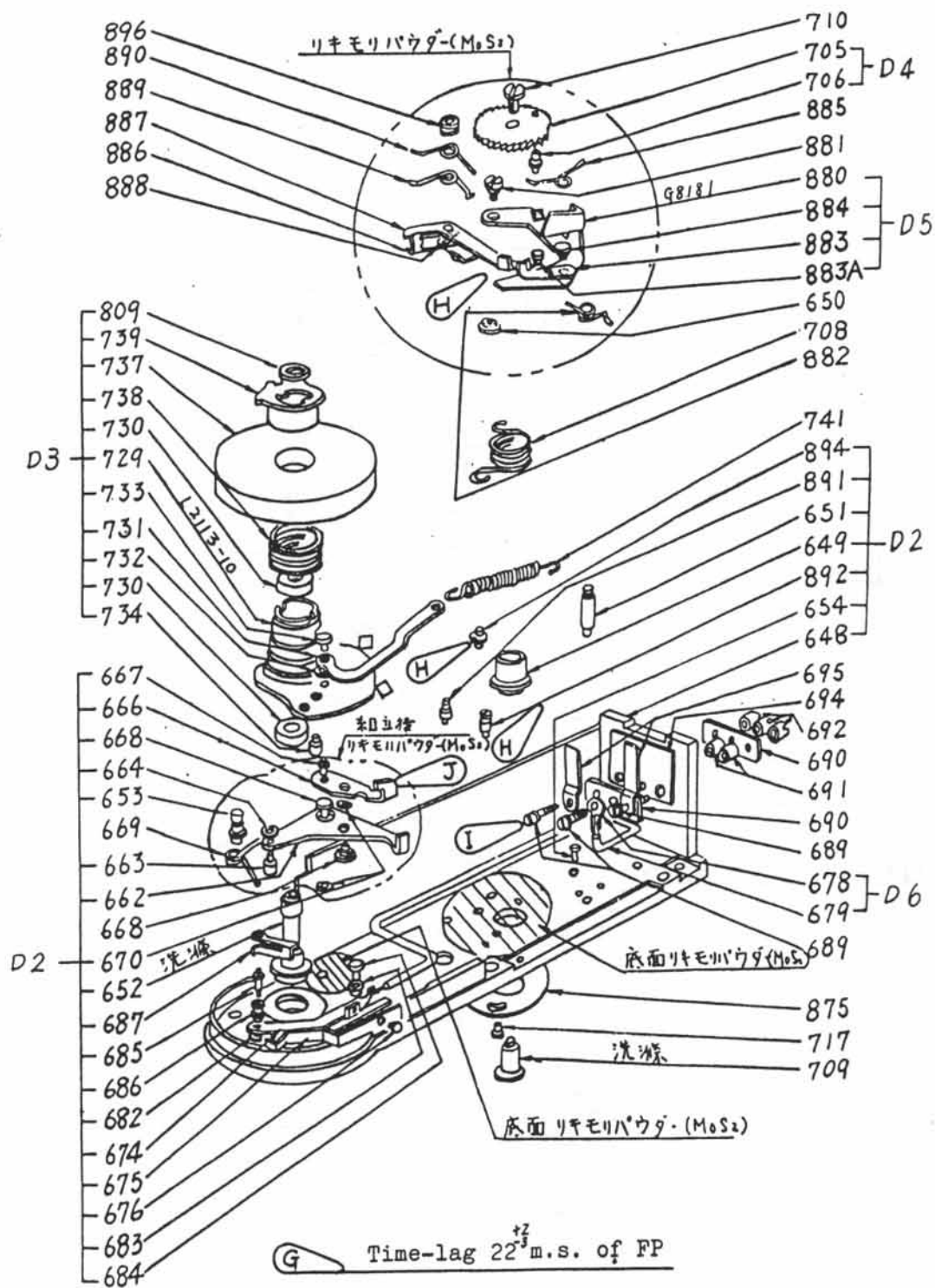

D1-----全部品

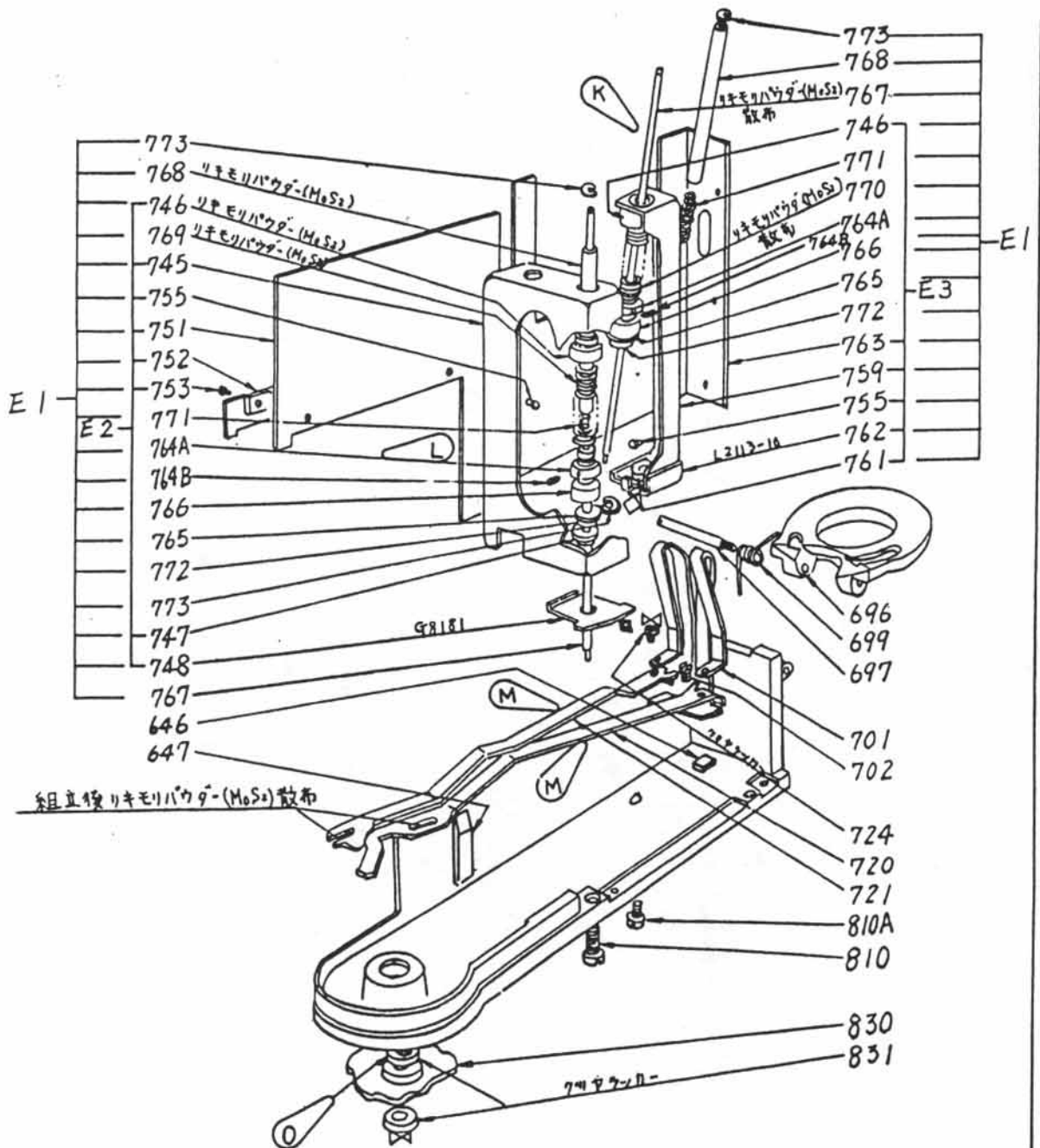

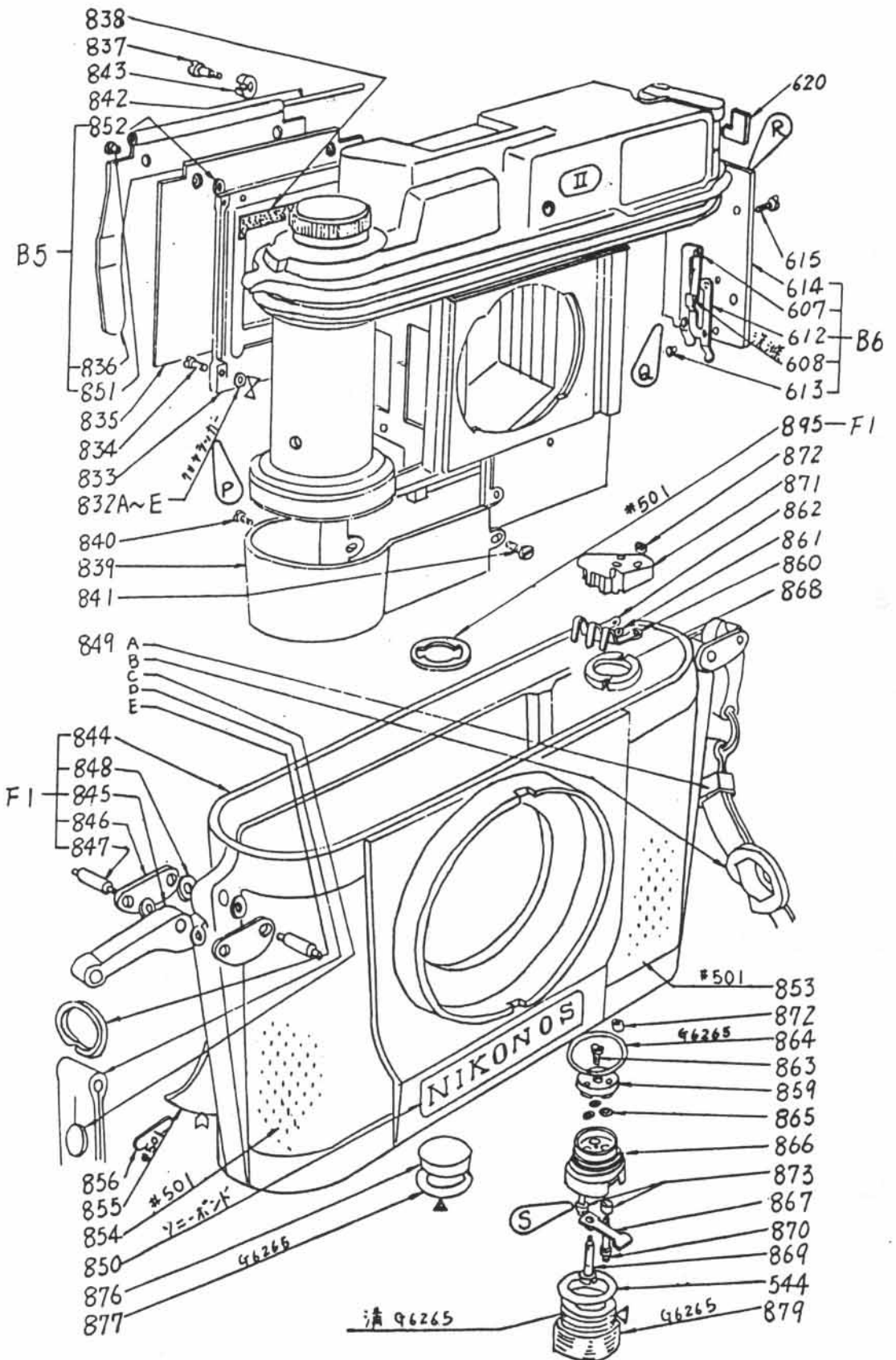

N Assembling



- (A) Both vertical and lateral sighting directions of the accessory shoe are to be correct within 10' and the inclination within 20'.
Use cementing agent #616.
- (B) Make sure that #634 and #622 are disengaged from each other when the shutter speed dial is set to R. Take care of the direction of #821.
- (C) After turning #604 a full or one and a half rotation in the direction of the arrow, set it with #610.
- (D) Make engagement so that the punch mark on the gear #794, the center of #783 and the punch mark on the gear #642 are exactly aligned.
- (E) Passing an L-shaped tool  through the holes (C) and (D), twist #622 about 3 rotations. Set #779 to the hole (A) through the hole (B) by means of set screw #618.
- (F) Wind up the lever (#813) until the alignment as described in (D) is realized. In this position raise #794 and keep it free from gearing with #783. While closing the winding lever, draw out subassembly #794 through the cut off part of #778.
- (G) The time-lag $22 \pm \frac{2}{5}$ m.s. of FP is a time to elapse between switching on of the FP circuit and appearance of the end of the front curtain at the start of running at 1/500 sec. shutter speed. The correct time-lag of FP contact is to be attained by smooth rotation of subassembly #729 - #739. No oil is used.

- H Adjusting #894, bring the locking pawl (#887) in engagement with the third tooth from the untoothed end of the ratchet wheel #705. Through the adjustment of #892, have the driving pawl (#883) engaged with the first tooth on the ratchet (#705) as illustrated here after the adjustments make sure of the correct zero return, etc.

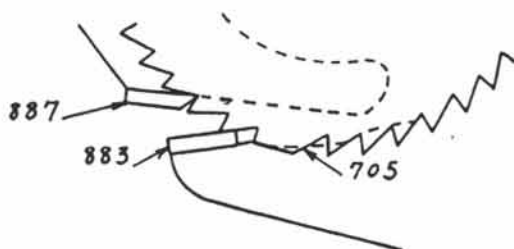

- I The body earthing screws, after completely screwed into #648, are to be secured with #692. Never use oil, cementing agent, etc. which is liable to reduce the contact efficiency.

- J Operation of #666 is to be smooth. If necessary, lubricate the axle (#668) with lubricant #7818 (10%). The starting position of the front curtain is to be adjusted by bending () the end of #666. Note: Rotating slowly #729 at 1/500 sec. with your finger, make sure of the position of 0.5mm where the front curtain starts running.

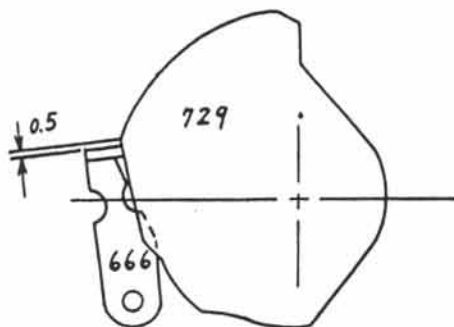

- K For disassembly, remove #773, draw out #768 and #771, pull upward #767, and make the bottom end free from #761. For reassembling, reverse the disassembling procedure.
- L Time balance between the beginning, intermediate and ending of the shutter curtain running is adjusted by the vertical movement of #764A. The same adjusting method can be applied to the front and rear curtains.
- M Distances of the pawl ends of #720 and of #721 from the bottom plate are to be 3mm and 1.8mm, respectively.
- N Holding the camera upside-down with the winding lever closed, insert the shutter subassembly and then the bottom plate subassembly. Fitting the end of #767 to the hole in the bottom plate, engage the picture frame counter advancing stud (#893) with #880. After inserting the bottom plate completely, secure it with #810 and #810A.
- O Loosen the nut (#831) found inside #830 as far as one revolution from the tightly fastened position. While assembling #830 and #831, apply clear lacquer. If the operation of B-setting is found unstable, check the relative positions of #822, #823 and #825.

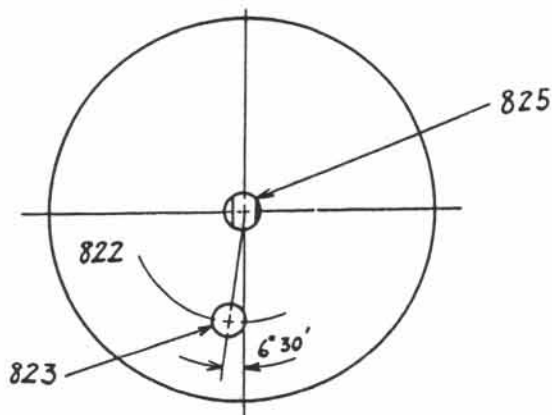

P

The flange back (from the lens thrust surface to the outer rail = $27.02_{mm}^{+0.02}$) is adjusted by changing the thickness of washer #832 A — D (0.04 — 0.1mm).

Q

Lowering of contact efficiency of the x-contact may be attributed to dust or oil found inside the contact. Therefore, before assembly, wash the contact part with alcohol or the like.

R













Even after #833 has been attached, #B6 can be inserted or taken out in the way illustrated here. Take care in this case not to injure the contact point.













S

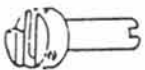



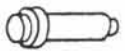







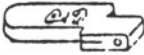

If the synch. contact takes in water by careless handling, insufficient insulation and corrosion may result; it is necessary to disassemble and to wash the contact. Then, make reassembly after drying. In this case check the insulation resistance.





NIKONOS - II (35mm/2.5) USE OF O-RING













	Part No.	Position To Be Used	Pcs.	Relating Part	
4	543	Finder window gasket	1	G11 - 536	3
8	544	Finder eyepiece and synchro socket	2	G13 - 536 844 - 879	6
4	552	Safety device	1	551 - 553	3
4	556	Rewind fork	1	536 - 557	3
4	579	Fitting part of the camera top	1	536 - 844	3
8	772	Shutter curtain stopper	2	769	6
8	816	Winding lever and shutter dial shaft	2	536 - 811 811 - 820	6
4	864	Synchro C-cover	1	844 - 866	3
4	877	Exposure counter window	1	844 - 876	3
8	865	Synchro contact axle	3	869, 870 - 866	9
4	917A	Knob	2	901 - 911, 912	6
4	917B	Outer housing and fitting part of lens	1	844 - 901	3
4	917C	Water-tight glass	1	G7 - 901	3



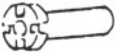









No. of Part	Name and Shape	Pcs. per Unit	No. of Subassembly	Ref. Fig. No.	Term of Sale	Remarks
9F2B-536	Top cover 	1	Al	1	△	
537	Guide pin 	4	Al Bl	1	○△	*
539	Bolt 	1		2	○	
540	Spring guide ring 	1	Al	1	○△	
541	Finder window frame 	1		1	○	*
543	Finder window gasket 	1		1	○	*
544	O-ring 	2		1	○	*
545	Finder eyepiece washer 	1		1	○	*
546	Shoe screw A 	2		1	○	
547	Shoe adjusting washer 	1		1	○	*
548	Shoe screw B 	1		1	○	
549	Accessory shoe 	1		1	○	
550	Shoe spring 	1		1	○	





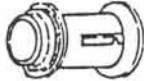





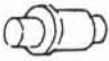

No. of Part	Name and Shape	Pcs. per Unit	No. of Subassembly	Ref. Fig. No.	Term of Sale	Remarks
9F2B-551	Safety lever 	1		1	○	*
552	O-ring 	1		1	○	*
553	Safety lever screw 	1		1	○	
554	Safety lever washer 	1		1	○	*
556	O-ring 	1		1	○	*
557	Rewind shaft 	1	A4	1	○△	
558	Rotating plate 	1		1	○	
559	Rotating plate screw 	1		1	○	*
560	Rotating plate washer 	1		1	○	*
561	Crank knob 	1	A4 A5	1	△	
562	Knob shaft 	1	A4 A5	1	△	
563	Crank lever shaft 	1	A4	1	○△	
564	Rewind shaft coupler 	1	A6	1	△	*
565	Rewind A-gear 	1	A6	1	△	*













No. of Part	Name and Shape	Pcs. per Unit	No. of Subassembly	Ref. Fig. No.	Term of Sale	Remarks
9F2B-566	A-gear pin 	1	A6	1	○△	*
567	Crank spring 	1	A4	1	○△	
568	Crank lever 	1	A4 A5	1	△	
569	Rewind B-gear 	1	A7	1	△	
570	Rewind axle base plate 	1	A7	1	△	
571	Rewind fork 	1	A7	1	○△	
572	Rewind C-gear 	1	A7	1	○△	
573	Rewind C-gear axle 	1	A7	1	△	
574	Knob washer 	1	A4 A5	1	○△	
575	Rewind B-gear axle 	1	A7	1	△	
576	Rewind axle base screw 	3		1	○	*
577	Spring screw 	1	A4	1	○△	
578	Winding lever C-screw 	1		1	○	
579	O-ring 	1		1	○	*





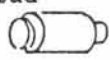



No. of Part	Name and Shape	Pcs. per Unit	No. of Subassembly	Ref. Fig. No.	Term of Sale	Remarks
9F2B-						
586	Inner camera housing 	1	B1	1	△	*
589	Washer 	1		2	○	*
590	Rewind shaft set screw 	1	A7	1	○△	
591	Charge lever stopper 	1	B1	1	○△	*









No. of Part	Name and Shape	Pcs. per Unit	No. of Subassembly	Ref. Fig. No.	Term of Sale	Remarks
9F2B-596	Charge lever 	1	B3	1	△	*
597	Charge lever spindle 	1	B3	1	△	*
598	Charge lever pin 	1	B3	1	△	*
600	Joint 	1	B3	1	△	*
601	Connecting lever 	1	B3	1	△	*
602	Joint pin 	2	B3	1	△	*
604	Charge lever C-sleeve 	1		1	○	*
605	Charge lever spring 	1		1	○	*
606	C-sleeve axle 	1		1	○	*
607	Earth piece A 	1	B6	5	△	
608	Contact piece 	2	B6	5	△	
609	Rear picture frame 	1		1	○	*
610	Sleeve stopper 	1		1	○	*











No. of Part	Name and Shape	Pcs. per Unit	No. of Subassembly	Ref. Fig. No.	Term of Sale	Remarks
9F2B-						
612	Conducting piece A 	1	B6	5	△	
613	Conducting piece rivet 	4	B6	5	△	*
614	Conducting piece attaching plate 	1	B6	5	△	
615	Attaching plate screw 	2		5	○	*
616	Winding shaft spring 	1		2	○	
617	Spring holder 	1		2	○	
618	Spring holder set screw 	1		2	○	
619	Spool spring 	1		2	○	
620	Light baffle 	1		5	○	
622	Spool 	1	C2	2	△	*
623	Spool gear rivet 	3	C2	2	△	*
624	Spool gear 	1	C2	2	△	*
625	AR lever pin 	1	A3	1	△	





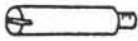

No. of Part	Name and Shape	Pcs. per Unit	No. of Subassembly	Ref. Fig. No.	Term of Sale	Remarks
9F2B-626	Washer 	2		1	○	
628	Film advance spring 	1	B4	2	△	*
629	Spring stud A 	1	B4	2	△	*
630	Spring stud B 	1	B4	2	△	*
631	Winding shaft spring stud 	1		1	○	
632	Film advance lever spring 	1		2	○	*
633	Film advance lever washer 	1		2	○	*
634	AR lever 	1	A3	1	△	
635	AR lever axle 	1		1	○	
636	AR lever axle bearing 	2	A2 A3	1	△	
637	Winding shaft base 	1	B2	1	△	*
638	Charge lever stopper 	1	B2	1	△	*
639	Winding shaft bearing 	1	B2	1	△	*
640	AR lever spring 	1		1	○	







No. of Part	Name and Shape	Pcs. per Unit	No. of Subassembly	Ref. Fig. No.	Term of Sale	Remarks
9F2B-641	Rewinding release lever 	1	A2	1	△	
642	Fixing gear 	1		1	○	*
643	Fixing gear screw 	2		1	○	*
646	Light baffle A 	1		4	○	
647	Light baffle B 	1		4	○	
648	Bottom plate 	1	D1 D2	3	△	*
649	E.C. spring holder 	1	D1 D2	3	△	*
650	E.C. nut 	1	D1	3	△	*
651	Fly wheel spring stud 	1	D1 D2	3	△	*
652	Fly wheel shaft 	1	D1 D2	3	△	*
653	Driving rod guide 	1	D1 D2	3	△	*
654	Driving spring guide 	2	D1 D2	3	△	*









No. of Part	Name and Shape	Pcs. per Unit	No. of Subassembly	Ref. Fig. No.	Term of Sale	Remarks
9F2B-						
662	Shutter speed lever 	1	D1 D2	3	△	*
663	Shutter speed lever pin 	1	D1 D2	3	△	*
664	Shutter speed lever pin base 	1	D1 D2	3	△	*
666	Driving rod lever 	1	D1 D2	3	△	*
667	Driving rod lever pin 	1	D1 D2	3	△	*
668	Shutter speed lever axle 	2	D1 D2	3	△	*
669	Shutter speed lever spring 	1	D1	3	○△	*
670	Shutter speed lever washer 	2	D1 D2	3	△	*









No. of Part	Name and Shape	Pcs. per Unit	No. of Subassembly	Ref. Fig. No.	Term of Sale	Remarks
9F2B-						
674	Synchro A-contact 	1	D1 D2	3	△	*
675	Synchro B-contact 	1	D1 D2	3	△	*
676	Contact securing rivet 	1	D1 D2	3	△	*
678	Terminal tip 	1	D1 D6	3	△	*
679	Cord (black) 	1	D1 D6	3	△	*
682	Insulating A-plate 	1	D1 D2	3	○△	*
683	Insulating A-ring 	1	D1 D2	3	○△	*
684	A-ring rivet 	1	D1 D2	3	○△	*
685	B-ring rivet 	1	D1 D2	3	○△	*













No. of Part	Name and Shape	Pcs. per Unit	No. of Subassembly	Ref. Fig. No.	Term of Sale	Remarks
9F2B-686	Insulating B-ring 	1	D1 D2	3	○△	*
687	FP earth contact 	1	D1 D2	3	○△	*
689	MX screw 	3	D1	3	○△	*
690	MX insulating plate-A 	2	D1	3	○△	*
691	Insulating C-ring 	2	D1	3	○△	*
692	MX nut 	3	D1	3	○△	*
694	X insulating plate 	1	D1	3	○△	
695	Contact piece 	2	D1	3	○△	
696	Film cartridge holder 	1		4	○	*
697	Cartridge holder axle 	1		4	○	*
699	Cartridge holder spring 	1		4	○	*





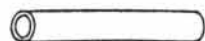
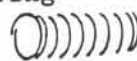



No. of Part	Name and Shape	Pcs. per Unit	No. of Subassembly	Ref. Fig. No.	Term of Sale	Remarks
9F2B-701	Driving spring 	1		4	○	*
702	Driving spring screw 	1		4	○	*
705	Ratchet 	1	D1 D4	3	△	*
706	E.C. return spring hook 	1	D1 D4	3	△	*
708	E.C. return spring 	1	D1	3	○△	*
709	Exposure counter 	1	D1	3	○△	*
710	E.C. screw 	1	D1	3	○△	*







No. of Part	Name and Shape	Pcs. per Unit	No. of Subassembly	Ref. Fig. No.	Term of Sale	Remarks
9F2B-						
717	E.C. screw 	2	D1	3	○△	*
720	Front curtain release lever 	1		4	○	*
721	Rear curtain release lever 	1		4	○	*
724	Driving lever screw 	2		4	○	*
729	Shutter speed cam 	1	D1 D3	3	△	*
730	Fly wheel bearing 	2	D1 D3	3	△	*



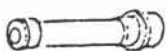









No. of Part	Name and Shape	Pcs. per Unit	No. of Subassembly	Ref. Fig. No.	Term of Sale	Remarks
9F2B-731	Wheel coupling lever 	1	D1 D3	3	△	*
732	Coupling lever washer 	1	D1 D3	3	△	*
733	Coupling lever axle 	1	D1 D3	3	△	*
734	Synchro conducting stud 	1	D1 D3	3	△	*
737	Fly wheel 	1	D1 D3	3	△	*
738	Fly wheel spring 	1	D1 D3	3	△	*
739	Shutter release pawl 	1	D1 D3	3	△	*
741	Fly wheel driving spring 	1	D1	3	○△	*
745	Front curtain bearing 	1	E1 E2	4	△	*











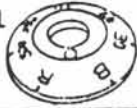

No. of Part	Name and Shape	Pcs. per Unit	No. of Subassembly	Ref. Fig. No.	Term of Sale	Remarks
9F2B-746	Front curtain bearing A-sleeve 	2	E1, E2 E3	4	△	*
747	Front curtain bearing B-sleeve 	1	E1 E2	4	△	*
748	Front curtain pawl 	1	E1 E2	4	△	*
751	Front curtain 	1	E1 E2	4	△	*
752	Light baffle plate 	1	E1 E2	4	△	*
753	Light baffle rivet 	2	E1 E2	4	△	*
755	Curtain rivet 	6	E1, E2 E3	4	△	*
759	Rear curtain bearing 	1	E1 E3	4	△	*









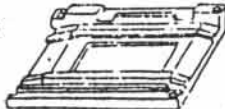





No. of Part	Name and Shape	Pcs. per Unit	No. of Subassembly	Ref. Fig. No.	Term of Sale	Remarks
9F2B-761	Rear curtain bearing B-sleeve 	1	E1 E3	4	△	*
762	Rear curtain pawl 	1	E1 E3	4	△	*
763	Rear curtain 	1	E1 E3	4	△	*
764A	Spring adjusting collar 	2	E1	4	○△	*
764B	Spring adjusting collar set screw 	2	E1	4	○△	*
765	Curtain axle washer 	2	E1	4	○△	*
766	Guiding cylinder 	2	E1	4	○△	*
767	Curtain axle 	2	E1	4	○△	*
768	Spring guide 	2	E1	4	○△	*
769	Front curtain spring 	1	E1	4	○△	*
770	Rear curtain spring 	1	E1	4	○△	*
771	Curtain spring 	2	E1	4	○△	*
772	O-ring 	2	E1	4	○△	*
773	Snap ring 	4	E1	4	○△	*























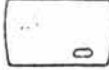





No. of Part	Name and Shape	Pcs. per Unit	No. of Subassembly	Ref. Fig. No.	Term of Sale	Remarks
9F2B-						
778	Gear holder plate 	1	C3	2	△	
779	Winding shaft-B 	1	C3	2	△	
780	Supporting stud 	2	C3	2	△	*
782	Winding gear bearing 	1	C3	2	△	*
783	Planet gear 	1	C3	2	△	
784	Winding coupling lever 	1	C3	2	△	
785	Winding coupling pin 	1	C3	2	△	*
787	Snap ring 	1		2	○	*
788	Friction washer 	1		2	○	*













No. of Part	Name and Shape	Pcs. per Unit	No. of Subassembly	Ref. Fig. No.	Term of Sale	Remarks
9F2B-						
794	Sun gear 	1	C4	2	△	*
795	Sun gear shaft 	1	C4	2	△	*
797	Spool driver stopper 	1	C4	2	△	*
798	Change-over lever sleeve 	1	C4	2	△	*
801	Spool gear driver 	1	C4 C5	2	△	
802	Spool gear driver pin 	1	C4 C5	2	△	*
804	Change-over lever 	1	C4	2	○△	*















No. of Part	Name and Shape	Pcs. per Unit	No. of Subassembly	Ref. Fig. No.	Term of Sale	Remarks
9F2B-805	Change-over lever axle 	1	C4	2	○△	*
806	Snap ring 	1	C4	2	○△	*
807	Reciprocating spring 	1	C4	2	○△	*
809	Fly wheel collar 	1	D1 D3	3	○△	*
810	Bottom plate screw A 	2		4	○	*
810A	Bottom plate screw B 	1		4	○	*
811	Winding shaft 	1	C6	2	△	
813	Winding lever 	1	C6	2	△	
814	Click spring 	1		2	○	*
816	O-ring 	2		2	○	*
817	AR spring nut 	1		2	○	
818	AR spring screw 	1		2	○	









No. of Part	Name and Shape	Pcs. per Unit	No. of Subassembly	Ref. Fig. No.	Term of Sale	Remarks
9F2B-819	AR spring 	1		2	○	
820	Shutter speed knob 	1	C1	2	△	
821	AR change-over cam 	1		2	○	
822	Shutter speed dial 	1	C1	2	△	
823	Speed dial stopper pin 	1	C1	2	△	*
824	AR spring screw 	1		2	○	
825	Speed dial axle 	1	C1	2	△	*
827	Shutter speed dial bearing 	1		2	○	
828	Shutter speed axle nut 	1	C1	2	△	
829	Winding lever washer 	1		2	○	*
830	Shutter speed cam 	1		4	○	*
831	Speed cam nut 	2		4	○	*
832A-E	Washer 	4		5	○	*
833	Picture frame 	1		5	○	*



No. of Part	Name and Shape	Pcs. per Unit	No. of Subassembly	Ref. Fig. No.	Term of Sale	Remarks
9F2B-834	Picture frame screw 	4		5	○	*
835	Pressure plate 	1	B5	5	△	
836	Pressure plate spring 	1	B5	5	△	
837	Hinge bearing screw 	2		5	○	
838	Light baffle 	1		5	○	
839	Fly wheel cover 	1		5	○	*
840	Fly wheel cover A-screw 	1		5	○	*
841	Fly wheel cover B-screw 	1		5	○	*
842	Hinge shaft 	1		5	○	
843	Hinge bearing 	2		5	○	
844	Outer housing 	1	F1	5	△	
845	Inner housing raiser 	2	F1	5	○△	*
846	Raiser support 	4	F1	5	○△	*
847	Neck strap pin 	4	F1	5	○△	*
848	Washer 	8	F1	5	○△	*

No. of Part	Name and Shape	Pcs. per Unit	No. of Subassembly	Ref. Fig. No.	Term of Sale	Remarks
9F2B-849	Neck strap A - D 	1		5		*
850	Name plate 	1		5		*
851	Pressure plate spring rivet 	2	B5	5		
852	Rivet washer 	2	B5	5		
853	Right front leatherette 	1		5		*
854	Left front leatherette 	1		5		*
855	Back leatherette 	1		5		
856	Name plate 	1		5		
857	Mark plate 	1		1		
859	Synchro B-cover 	1		5		
860	X-contact B 	1		5		
861	M-contact 	1		5		
862	Earth contact 	1		5		
863	B-cover screw 	1		5		

No. of Part	Name and Shape	Pcs. per Unit	No. of Subassembly	Ref. Fig. No.	Term of Sale	Remarks
9F2B-864	O-ring 	1		5	○	
865	O-ring 	3		5	○	
866	Synchro C-cover 	1		5	○	
867	Earth contact C 	1		5	○	*
868	Synchro C-cover nut 	1		5	○	
869	Contact A-axle 	1		5	○	
870	Contact B-axle 	2		5	○	
871	Synchro A-cover 	1		5	○	
872	Contact setting nut 	6		5	○	*
873	B-axle insulating cover 	2		5	○	
875	Exposure counter 	1	D1	3	○△	*
876	Counter window 	1		5	○	*
877	O-ring 	1		5	○	*

No. of Part	Name and Shape	Pcs. per Unit	No. of Subassembly	Ref. Fig. No.	Term of Sale	Remarks
9F2B-879	Tripod socket 	1		5	○	*
880	Counter lever 	1	D1 D5	3	△	*
881	Counter axle 	1	D1	3	○ △	*
882	Counter lever spring 	1	D1	3	○ △	*
883	Counter pawl 	1	D1 D5	3	△	*
883A	Counter pawl A-rivet 	1	D1 D5	3	△	*
884	Counter pawl rivet 	1	D1 D5	3	△	*
885	Counter pawl spring 	1	D1	3	○ △	*
886	Counter release lever 	1	D1	3	○ △	*
887	Counter stopper pawl 	1	D1	3	○ △	*
888	Counter stopper pawl washer 	1	D1	3	○ △	*
889	Counter driving spring 	1	D1	3	○ △	*
890	Counter stopper lever spring 	1	D1	3	○ △	*
891	Counter stopper lever axle 	1	D1 D2	3	△	*
892	Counter spring hook 	1	D1 D2	3	○ △	*

No. of Part	Name and Shape	Pcs. per Unit	No. of Subassembly	Ref. Fig. No.	Term of Sale	Remarks
9F2B-893	Counter advancing stud 	1	B3	1	○△	*
894	Counter stopper rivet 	1	D1 D2	3	○△	*
895	Light baffle washer 	1	F1	5	○△	*
896	Counter stopper lever nut 	1	D1	3	○△	*
849A	Binding metal 	1		5	○	*
849B	Buckle 	1		5	○	*
849C	Link 	2		5	○	*
849D	Belt 	1		5	×	*
849E	Ring 	2		5	○	*

No. of Part	Name and Shape	Pcs. per Unit	No. of Subassembly	Ref. Fig. No.	Term of Sale	Remarks
9F2B-G11	Objective lens 	1		1	○	
G12	Viewfield frame 	1		1	○	
G13	Eyepiece lens 	1		1	○	

	No. of Sub-assembly	Name	Pcs. per Unit	No. of Constituent Parts (*: Main parts)	Ref. Fig. No.	Remarks
Top cover	9F2B-A1	Top cover	1	*536, 537, 540	1	
	A2	Rewinding release lever	1	636, *641	1	
	A3	AR lever	1	625, *634, 636	1	
	A4	Crank lever	1	574, 561, 562, 568, 577 567, 563, *557	1	
	A5	Crank lever	1	574, 561, 562, *568	1	
	A6	Resind shaft coupler	1	566, *564, 565	1	
	A7	Rewind axle base plate	1	575, 569, 572, *570, 573 590, 571	1	
Inner camera housing	B1	Inner camera housing	1	*586, 537, 591	1	
	B2	Winding shaft base	1	*637, 638, 639	1	
	B3	Charge lever	1	*597, 893, 598, 596, 600	1	
	B4	Film advance spring	1	630, *628, 629	2	
	B5	Pressure plate	1	852, 836, 851, *835	5	
	B6	Contact piece	1	*614, 607, 612, 608, 613	5	
Winding	C1	Shutter speed dial	1	820, *822, 823, 825, 828	2	
	C2	Spool	1	*622, 623, 624	2	
	C3	Winding shaft-B	1	*779, 778m 783, 780, 784 782, 785	2	
	C4	Spool gear driver	1	795, 794, 797, 798, 802 *801, 807, 804, 805, 806	2	
	C5	Spool gear driver	1	*801, 802	2	
	C6	Winding lever	1	*813, 811	2	
Bottom plate	D1	Bottom plate A	1	*D2, D3, D4, D5, D6, 896 890, 889, 887, 886, 888 669, 710, 885, 881, 882 650, 708, 741, 695, 694 692, 690x2, 691, 689x2 875, 717, 709	3	
	D2	Bottom plate B	1	667, 666, 668x2, 664, 653 663, 662, 670, 652, 687 685, 686, 682, 674, 675 676, 683, 684, 894, 891 651, 649, 892, 654, *648	3	

	No. of Sub-assembly	Name	Pcs. per Unit	No. of Constituent Parts (*: Main parts)	Ref. Fig. No.	Remarks
Bottom plate	9F2B-D3	Shutter speed cam	1	739, 737, 738, 730x2, 733*729, 731, 732, 734, 809	3	
	D4	Ratchet	1	*705, 706	3	
	D5	Counter lever	1	*880, 884, 883, 883A	3	
	D6	Cord	1	678, *679	3	
Curtain	E1	Curtain	1	E2, E3, 768x2, 769, 771x2, 764Ax2, 764B, 766x2, 765x2, 772x2, 773x4*767x2, 770	4	
	E2	Front curtain	1	746, 745, 755, *751, 752, 753, 747, 748	4	
	E3	Rear curtain	1	746, *763, 759, 755, 762, 761	4	
Outer housing	F1	Outer housing	1	848, 845, 846, 847, *844, 895	5	